

USER MANUAL

HyperJump 4 Spring Trampoline



WARNING: The disassembled product may contain small parts which pose a choking hazard to children under 3.

IMPORTANT:

This product may contain sharp points and small parts prior to assembly. The owner's manual contains safety, assembly, use and maintenance instructions. This product must be assembled by an adult who has read and understood these instructions. Keep the packaging away from children and dispose of all packaging before use.

For the installer and your children's safety, it is important to fully read and understand the instructions and safety hazards before commencing the assembly of the product.

NOTE:

This manual should not be used to guide your purchasing decision. Your product, and the contents inside its carton, may vary from what is listed in this manual. This manual may also be subject to updates or changes. Updated manuals are available through our website at www.lifespankids.com.au.

TABLE OF CONTENTS

I. GENERAL SAFETY INSTRUCTIONS	3
1.1 Purpose	3
1.2 Danger for Children	3
1.3 Risk of Injuries	3
1.4 Product Damage	4
1.5 Assembly Advice	4
II. SAFETY INSTRUCTIONS	6
2.1 Accident Categories	8
III. ASSEMBLY INSTRUCTIONS	9
IV. SAFETY NET PRECAUTIONS	22
V. MAINTENANCE	23
VI. CLEANING	23
VII. EXERCISE DIAGRAMS	24
VIII. WARRANTY	25

I. GENERAL SAFETY INSTRUCTIONS

1.1 PURPOSE

This product is intended for indoor and outdoor, home, domestic use only. It is not suitable for commercial or medial use.

NOTE: Do not exceed the weight limit of the trampoline.

SIZE	8FT	10FT	12FT	14FT	16FT
Weight Limit	100kg	100kg	125kg	140kg	140kg

1.2 DANGER FOR CHILDREN



WARNING: Trampolines over 51cm (20 inches) in height are not recommended for children under six years of age.

WARNING: No eating while jumping.

- Children do not recognize potential dangers from this product. The product must be stored out of reach of children and pets.
- This product may only be used with adult supervision at all times.
- The packaging material is not suitable for children due to choking and suffocation hazards.

1.3 RISK OF INJURIES

- Do not use the product if it is damaged or defective. If it is damaged or defective, please contact a qualified technician.
- Check the product before each use. Defective parts must be changed immediately as they can impair the function and the safety of the product.
- No more than one person to use the product at the same time.
- Use the product only on even and non-slipping surfaces. Never use it near water and keep sufficient space around for safety.
- Beware of moving parts such as the springs or elastics, which could catch your arms and legs. Do not place any objects or body parts in the product's openings.

1.4 PRODUCT DAMAGE

- Do not make alterations to the product. Only use original spare parts. Qualified technicians should only carry out repairs – improper repairs can lead to danger for the user. Use this product only as described in this manual.
- Protect the product against splashes, humidity, high temperature and direct sunlight.

1.5 ASSEMBLY ADVICE

- The assembly of the product must be done carefully and by an able-bodied adult. If in any doubt, ask a technically qualified person.
- Before you start with the assembly, read the instructions carefully.
- Remove all packaging materials and lay down all parts on an open space. This gives you an overview and simplifies the assembly procedure.
- Check with the parts list that all parts are available. Dispose of the packaging material when the assembly is completed.
- Beware that when using tools or doing technical work, there is always a risk of injuries. Assemble the product with care.
- Create a danger free environment; for example, do not let tools lay around the workspace. Store the packaging material in a way that cannot cause any danger.
- After installing the product according to the instruction manual, ensure all screws, bolts and nuts are correctly installed and tightened and that all joints are secure.
- A free space of at least 9.5m is necessary above the trampoline. Reasonable space must be kept between the trampoline and possible sources of danger, such as power lines, tree branches, playing devices, swimming pools and fences.
- The trampoline must be assembled correctly before use.
- Never set up the trampoline in heavy rain, wind or storm conditions, especially in lightning conditions. It is recommended that the trampoline be taken apart and stored in bad weather.
- Place the trampoline on a level surface at least 2 m from any structure or obstruction such as a fence, garage, house, overhanging branches, laundry lines or electrical wires.
- Trampolines shall neither be installed over concrete, asphalt or any other hard surface nor at proximity of other conflicting installations (e.g. paddling pools, swings, slides, climbing frames).
- Modifications made to the original trampoline (e.g. the adding of an accessory) shall be carried out according to the instructions of the manufacturer.

- The metal frame of the trampoline will conduct electricity. Lightning, extension cords and all electrical equipment must never be allowed to come in contact with the trampoline.
- The trampoline must always be used in a well-lit area.
- Do not place anything under the trampoline.
- Use gloves during assembly and disassembly.
- Outdoor trampolines should be equipped with a device that in strong wind conditions avoid displacement due to wind (e.g. steel bars in the ground or loads like sand bag or water bags) and/or items catching wind like net and mat should be removed.
- In certain areas during winter, snow buildup and the low temperatures can damage the trampoline. It is recommended to remove snow buildup and to store the mat and the enclosure indoor.
- Replace the enclosure after 2 years of usage. This time indication is highly effected by weather conditions and the amount of UV exposure the trampoline is subject to. We strongly recommend visual inspections every 3 months to insure the integrity of the entire trampoline. Replace any parts as necessary.

II. SAFETY INSTRUCTIONS



WARNING: Do not land on the head or neck. There is the danger of paralysis or death, even if landing in the center of the trampoline. No somersaults should be attempted, in order to avoid danger of a head or neck landing.



WARNING: One person only at a time may use the trampoline. All children must be supervised while using the trampoline. Several persons jumping at the same time on the trampoline will increase the danger of control loss, collision or falls. This can lead to serious injury.

DO's

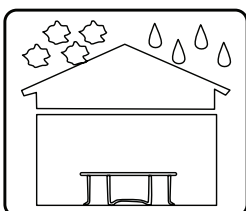
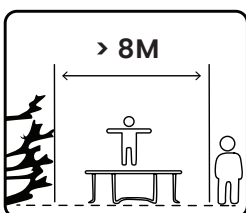
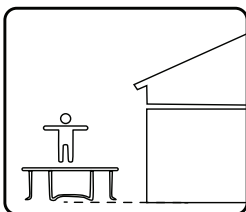
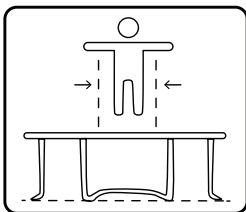
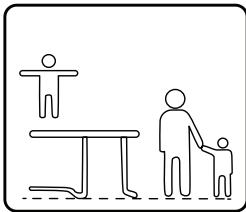

DON'Ts

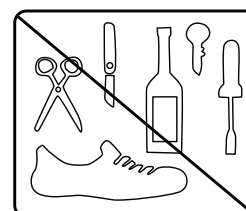
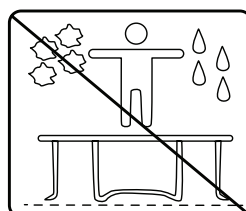
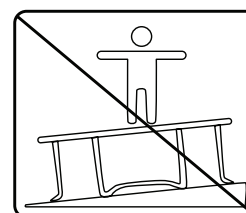
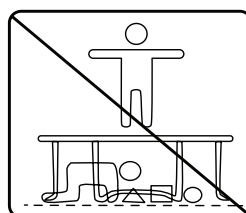
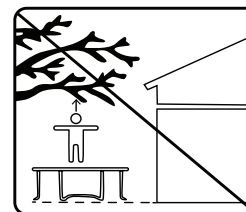
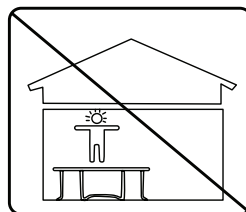
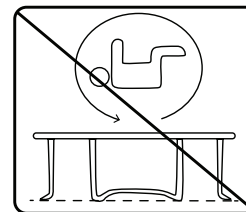
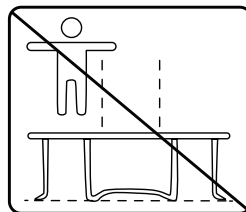
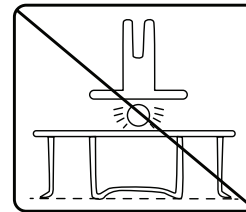
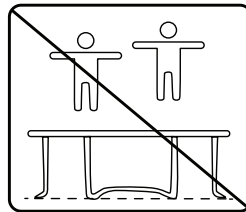

- The safety instructions of the product should always be considered and obeyed.
- Using the product may result in permanent injury such as paralysis, or even death. Falling off the product may lead to injuries, particularly to the back, neck or head.
- No clothes with hooks or loose parts should be worn or carried during product usage in order to avoid hooks getting caught and causing injury.
- Strong winds can result in the product being blown away or damaged. If strong winds are predicted the product must be disassembled and moved to a sheltered area or sufficiently anchored down.
- Moving the product whilst assembled may affect the integrity of the frame. Should it be necessary to move the product, please consider the following:
 1. At least four people must be evenly spaced around the frame to lift the trampoline off the ground.
 2. The product must be carried horizontally.
 3. Use caution whilst moving as it could bend the trampoline frame. If this occurs, use four people to draw the trampoline in shape.
- Users should be familiar with the assembly manual. This manual contains assembly guidance; selected precautionary measures as well as recommendations for servicing and maintenance of the trampoline, in order to ensure a secured and fun use of the Trampoline.
- It is the responsibility of the owner or the supervisor to guarantee that all users of the product are informed sufficiently of all warning references and safety instructions.

For the supervisor

The supervisor's role is to make sure users are aware of all safety precautions and that these precautions are enforced. When a supervisor is not available, the product may be disassembled or covered to limit access.

- Do not recommend this trampoline for children under 3 years of age.
- The trampoline can be only used, if the jumping mat is clean and dry. Worn or damaged jumping mats should immediately be replaced.
- Objects, which could be dangerous to the user, should be away from the trampoline.
- Avoid unauthorized and unsupervised use of the trampoline.
- Do not use the trampoline under influence of alcohol or drugs (incl. medicines).
- Learn the fundamental jump and body positions carefully, before trying difficult jumps.
- Stop jumping by bending your knees when your feet come to contact with the trampoline. The skill of braking should be used whenever you lose balance or control from a previous manoeuvre. Loss of balance or control will increase the risk of injury from landing on the frame, springs or completely off the trampoline. A controlled jump is considered landing on the same spot that you took off from. If you do lose control when you are jumping on the trampoline, bend your knees sharply when you land and this will allow you to regain control and stop your jump.
- Climb onto the trampoline. Do not jump on it directly. Do not use the trampoline as jumping board for other articles.

2.1 ACCIDENT CATEGORIES

SOMERSAULTS

A landing on the head or neck increases the risk of neck and back injuries, which can lead to paralysis and sometimes death. This can occur if the user makes an error and falls forward or backward. No somersaults should be attempted on the trampoline.

CLIMBING ON OR OFF THE TRAMPOLINE

The trampoline's jumping mat is approximately one meter above the ground. Jumping off the trampoline onto the ground or another surface can lead to an injury. Jumping onto the trampoline from a building roof, a terrace or other objects can lead to injury. Small children need assistance when climbing on or off the trampoline. Be careful when climbing on and off the trampoline. Do not step on the padding or the framework. Do not use the framework for climbing on or off the trampoline.

HITTING THE FRAMEWORK OR THE SPRINGS

Stay in the centre of the mat when playing jumping on the trampoline. This will reduce the risk of injury from landing on the frame or springs. Always keep the padding covering the frame of the trampoline. **DO NOT** jump or step onto the frame pad directly since it is not intended to support the weight of a person.

LOSS OF CONTROL

When users lose control of their jump, they can land incorrectly, on the framework, on the padding or fall off the trampoline. A controlled jump is one where the jumper lands and jumps from the same spot. If a manoeuvre is attempted, which exceeds the abilities of the jumper; there is a danger of losing control and increased chance of injury. In order to regain control of the jump and land correctly, knees should be completely bent upon landing.

UNDER INFLUENCE OF DRUGS OR ALCOHOL

The probability of an injury rises if the user is under the influence of alcohol or drugs. These substances weaken the response, the faculty of judgment, the space awareness, the coordination and the motor functions of the user.

COLLISION WITH OBJECTS

While using the trampoline, persons, animals or articles under it will increase the probability of an injury. Jumping on the trampoline whilst carrying an article, increases the probability of an injury. Placing the trampoline too close to electric wires, tree branches or other obstacles will also increase the probability of an injury.

BAD MAINTENANCE OF THE TRAMPOLINE

Users can hurt themselves if the trampoline is in bad condition. A torn jumping mat, bent framework, missing cushioning or missing framework must be replaced before using the trampoline again. The trampoline should be examined before each use.

WEATHER CONDITIONS

A wet jumping mat is too slippery for safe jumping. Gusty or strong winds can lead to a loss of jump control when jumping. In order to lower the probability of an injury, the trampoline should be used under suitable weather conditions only.

III. ASSEMBLY INSTRUCTIONS

MODEL	8'	10'	12'	14'	16'
Size	244cm	304cm	366cm	426cm	487cm
Total Height	246cm	270cm	270cm	270cm	270cm
Jumping Mat	76cm	90cm	90cm	90cm	90cm

Frame Specifications

MODEL	8'	10'	12'	14'	16'
Frame Cover	1	1	1	1	1
Jumping Mat	1	1	1	1	1
Top Rail	6	6	8	8	8
Metal Clips	42	60	72	80	108
Leg	6	6	8	8	8
Tools	1	1	1	1	1
Ladder	1	1	1	1	1

PARTS LIST

TOP FRAME RAIL



8ft MF083801 x 6pcs.
 10ft MF103801 x 6pcs.
 12ft MF124201 x 8pcs.
 14ft MF144201 x 8pcs.
 16ft MF164201 x 8pcs.

LEG SET

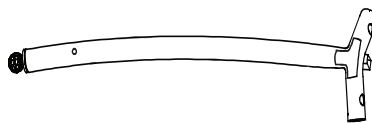

8ft ML3801 x 6pcs.
 10ft ML3802 x 6pcs.
 12ft ML3802 x 8pcs.
 14ft ML3802 x 8pcs.
 16ft ML3802 x 8pcs.

LEG BASE TOP + BOTTOM



8ft MP 082501 x 6pcs.
 10ft MP 102501 x 6pcs.
 12ft MP 122501 x 8pcs.
 14ft MP 142501 x 8pcs.
 16ft MP 162501 x 8pcs.

SPRING MAT

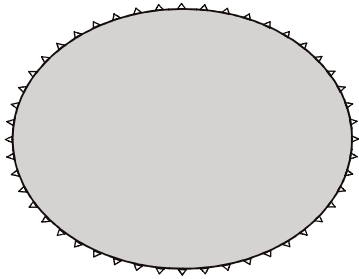

8ft JP0842 x 1pc.
10ft JP1060 x 1pc.
12ft JP1272 x 1pc.
14ft JP1480 x 1pc.
16ft JP16112 x 1pc.

PAD

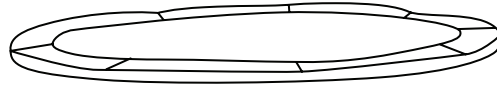

8ft P0801 x 1pc.
10ft P1001 x 1pc.
12ft P1201 x 1pc.
14ft P1401 x 1pc.
16ft P1601 x 1pc.

SPRINGS + FOAM COVER

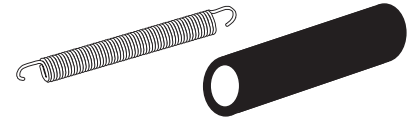

8ft S1401 x 42pcs.
10ft S1401 x 60pcs.
12ft S1781 x 72pcs.
14ft S1781 x 80pcs.
16ft S2141 x 112pcs.

BOLT 1



(M8 x 38mm)
8ft B8638 x 12pcs.
10ft B8638 x 12pcs.

(M8 x 42mm)
12ft B8642 x 16pcs.
14ft B8642 x 16pcs.
16ft B8642 x 16pcs.

BOLT 2



(M6 x 70mm)
8ft B6070 x 6pcs.
10ft B6070 x 6pcs.
12ft B6070 x 8pcs.
14ft B6070 x 8pcs.
16ft B6070 x 8pcs.

BOLT 3



(M6 x 32mm)
10ft B6032 x 6pcs.
12ft B6032 x 8pcs.
14ft B6032 x 8pcs.
16ft B6032 x 8pcs.

TOOLS

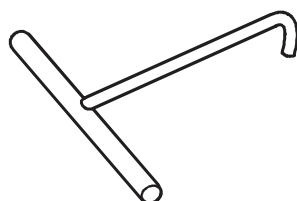

ALLEN KEY

NET POLE, BOTTOM



8ft/10ft
MP2501 x 6pcs.

12ft/14ft/16ft
MP2501 x 8pcs.

NET POLE, TOP

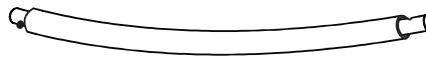

8ft/10ft
MP2501 x 6pcs.

12ft/14ft/16ft
MP2502 x 8pcs.

SLEEVE



8ft/10ft
Sleeve x 6pcs.

12ft/14ft/16ft
Sleeve x 8pcs.

SAFETY NET

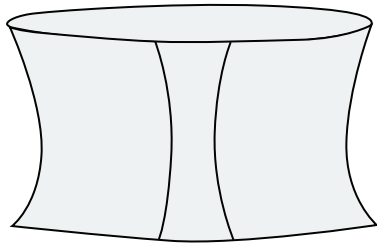

8ft S0801 x 1pc.
10ft S1001 x 1pc.
12ft S1201 x 1pc.
14ft S1401 x 1pc.
16ft S1601 x 1pc.

ROPE



8ft R0801 x 1pc.
10ft R1001 x 1pc.
12ft R1201 x 1pc.
14ft R1401 x 1pc.
16ft R1601 x 1pc.

METAL SURROUND CIRCLE

#C1



#C1-8ft 1055mm x 6pcs.
#C1-10ft 1040mm x 8pcs.
#C1-12ft 930mm x 11pcs.
#C1-14ft 1005mm x 12pcs.
#C1-16ft 1005mm x 9pcs.
930mm x 5pcs.

METAL SURROUND CIRCLE CONNECTOR

#C2



#C2-8ft x 6pcs.
#C2-10ft x 8pcs.
#C2-12ft x 11pcs.
#C2-14ft x 12pcs.
#C2-16ft x 14pcs.

BLOTS USED FOR SURROUND CIRCLE

PLASTIC HOLDER & FIXING SCREW

#P + #Q



#I + #R

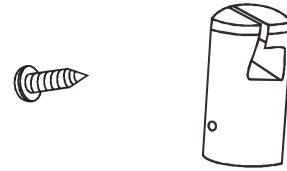

(M5 x 10mm Bolt with Nylock Nut)

- #P+#Q-8ft x 12pcs.
- #P+#Q-10ft x 16pcs.
- #P+#Q-12ft x 22pcs.
- #P+#Q-14ft x 24pcs.
- #P+#Q-16ft x 28pcs.

(M4 x 10mm Screw)

- #I+#R-8ft x 6pcs.
- #I+#R-10ft x 6pcs.
- #I+#R-12ft x 8pcs.
- #I+#R-14ft x 8pcs.
- #I+#R-16ft x 8pcs.

FRAME ASSEMBLY

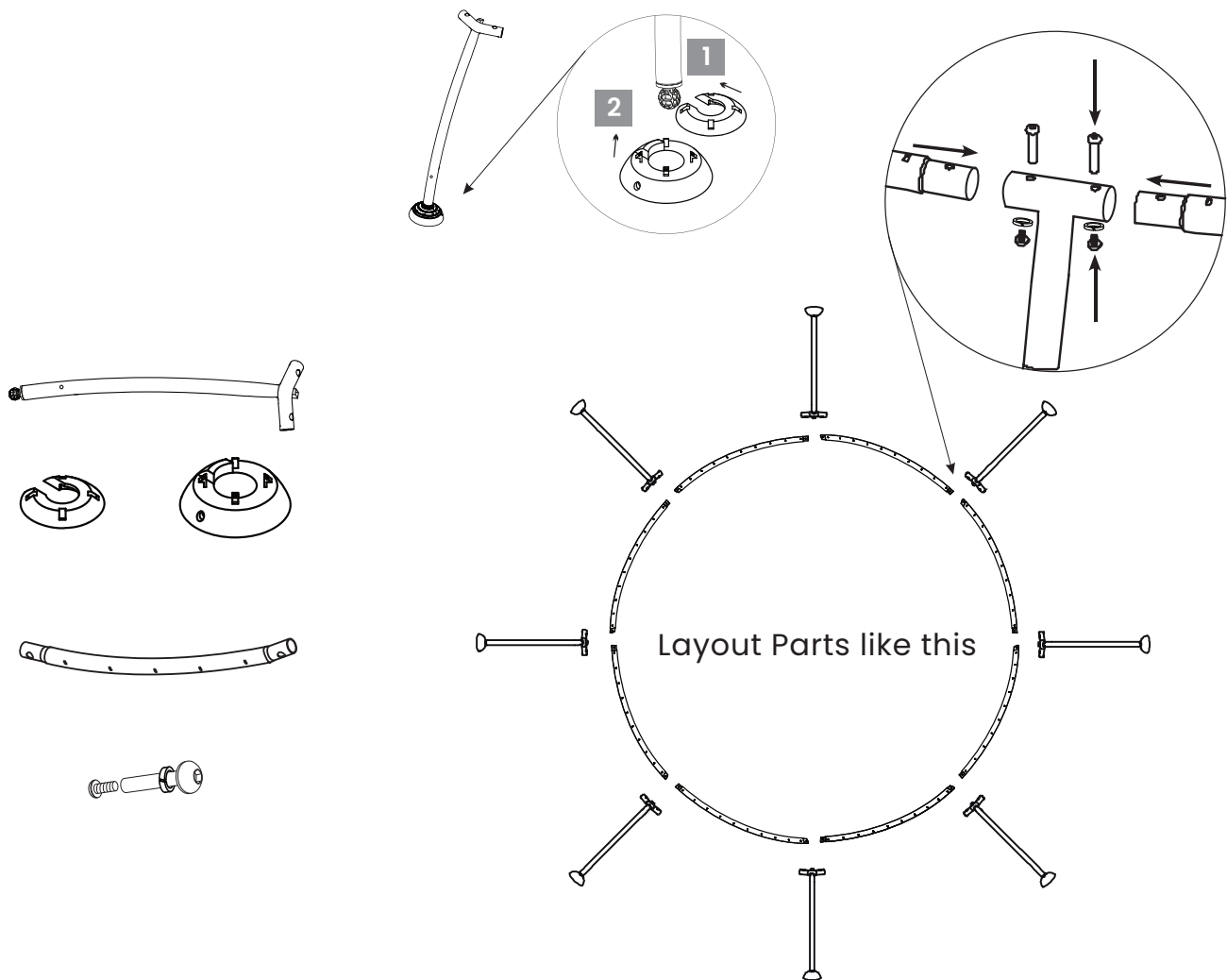

(A) 10FT, 14FT, 16FT BOTTOM FRAME ASSEMBLY

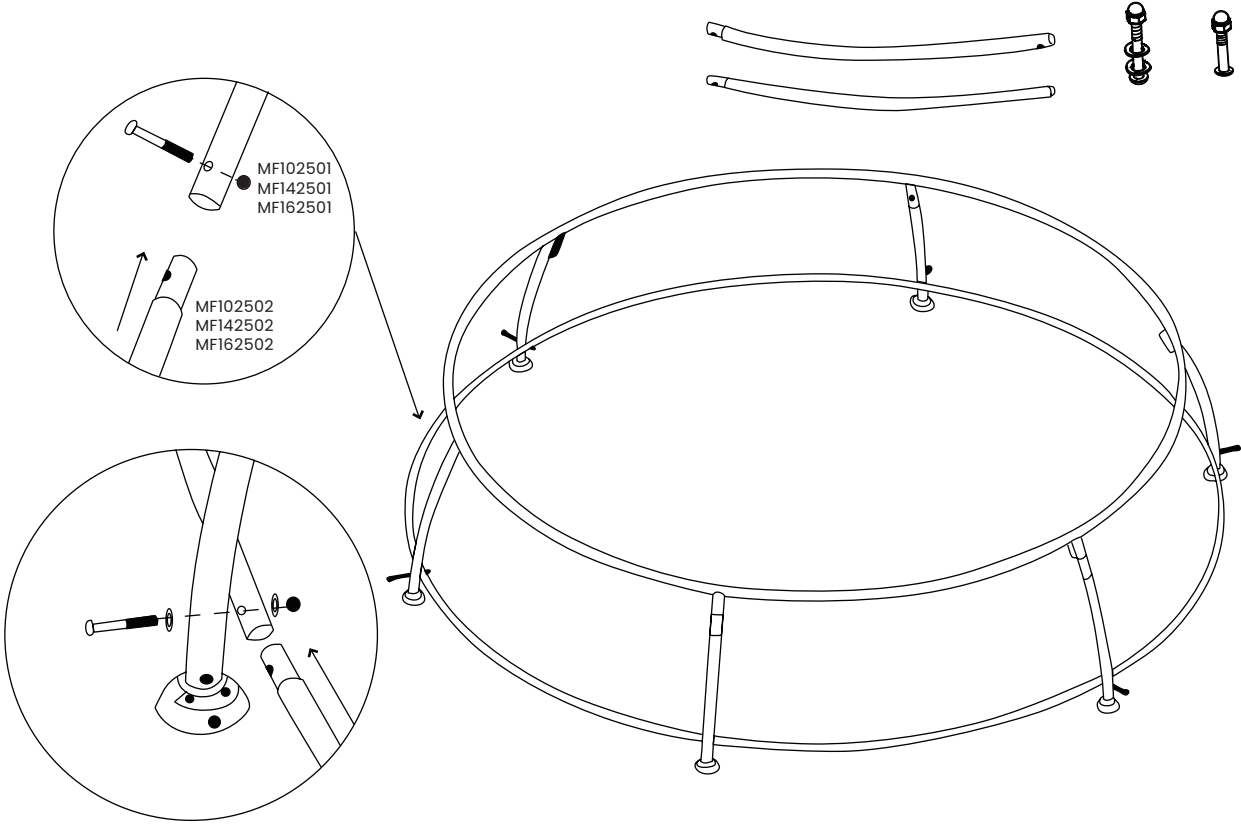

(B) 8FT, 12FT BOTTOM FRAME ASSEMBLY

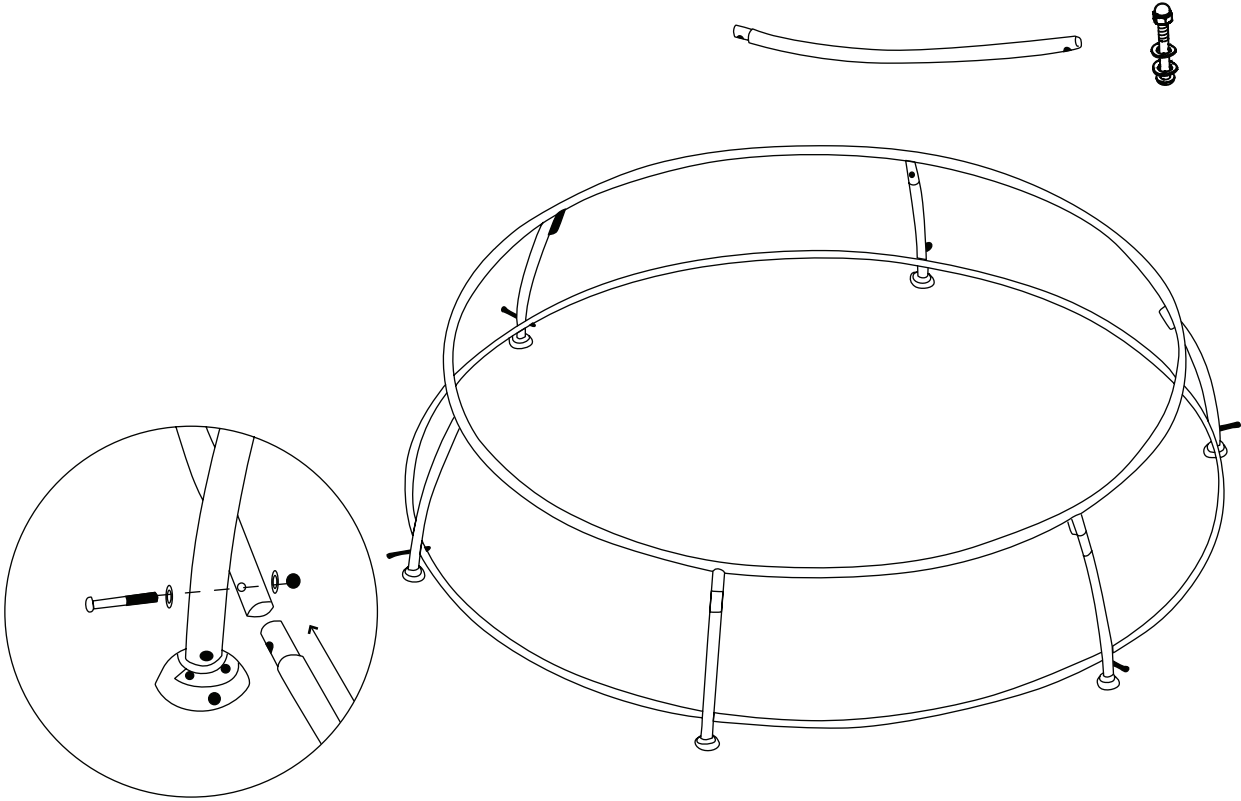

MAT ASSEMBLY

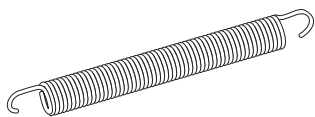
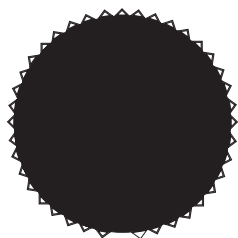

Foam Cover

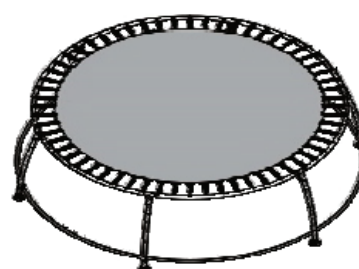
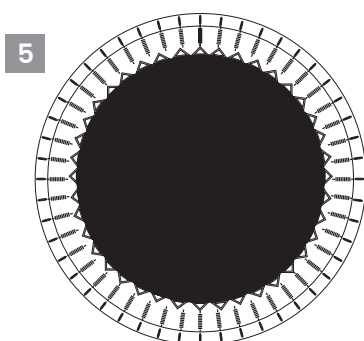
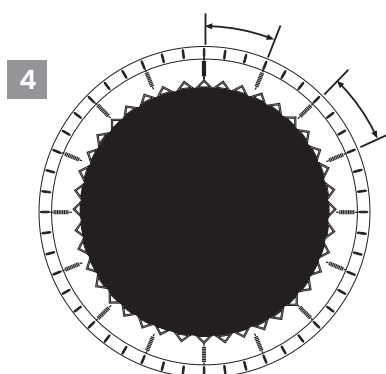
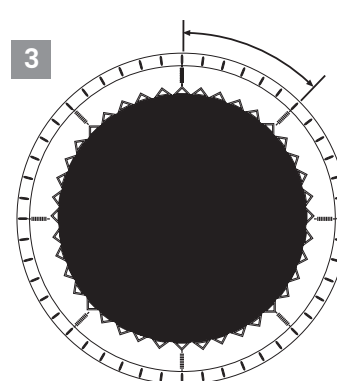
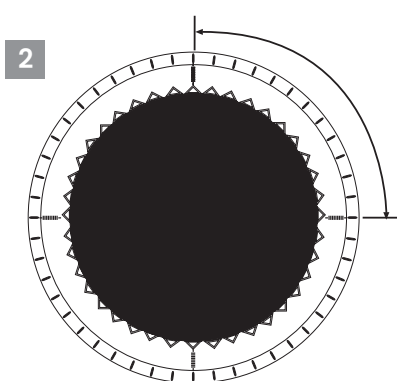
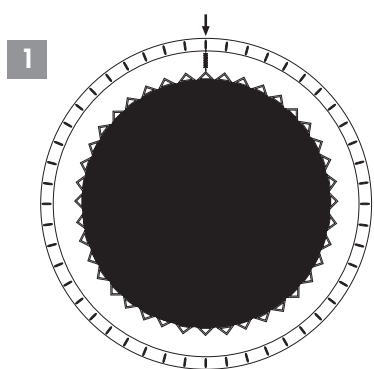
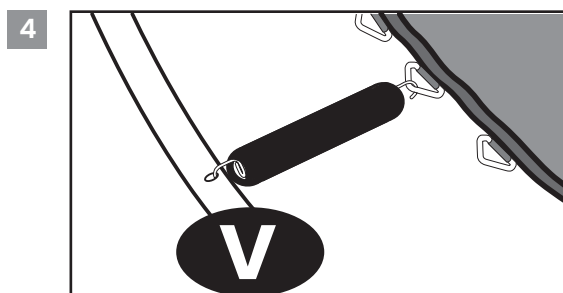
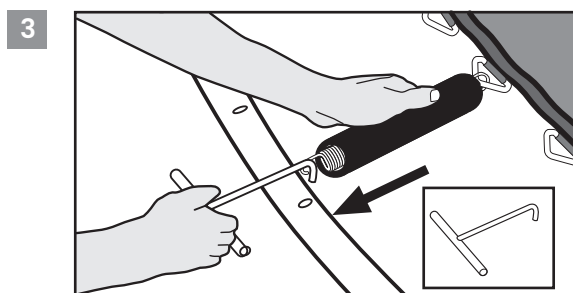
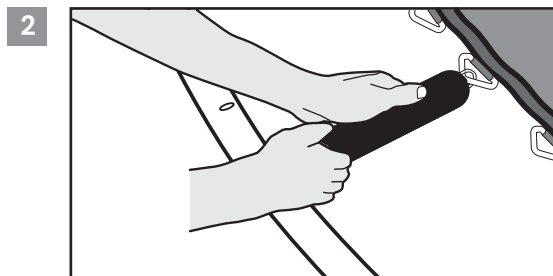
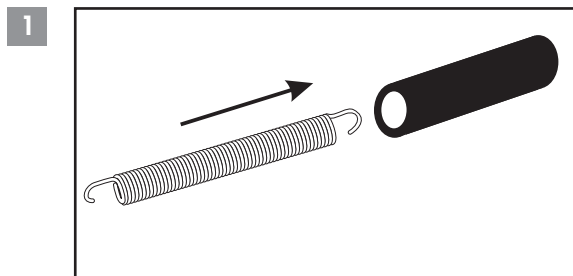

UPRIGHT POLE ASSEMBLY

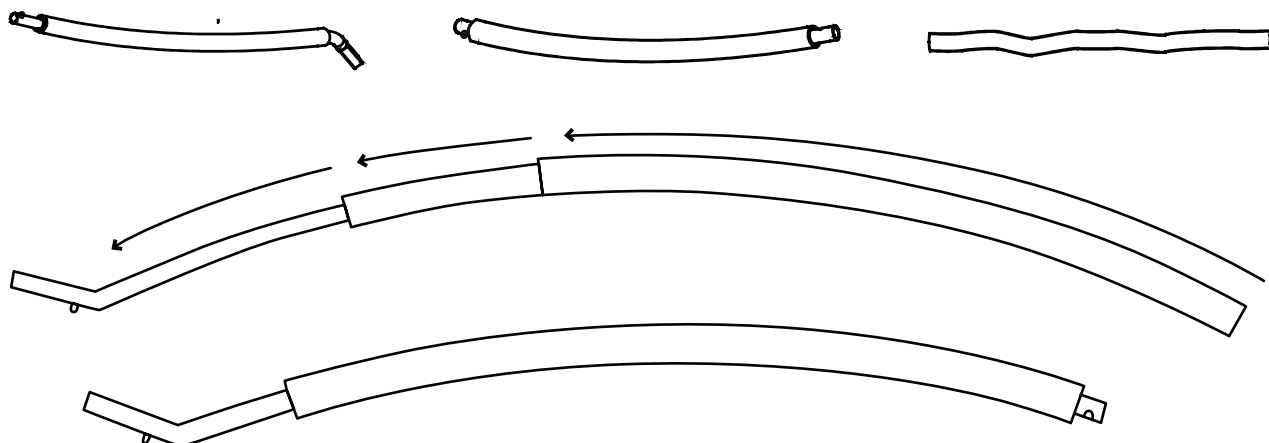

SURROUND TOP CIRCLE ASSEMBLY

- 1 WARNING:**
Please make sure to securely fasten the Flat Steel Bars together. Failing to do so may increase the chance of injury due to the enclosure frame snapping apart during assembly or trampoline use.

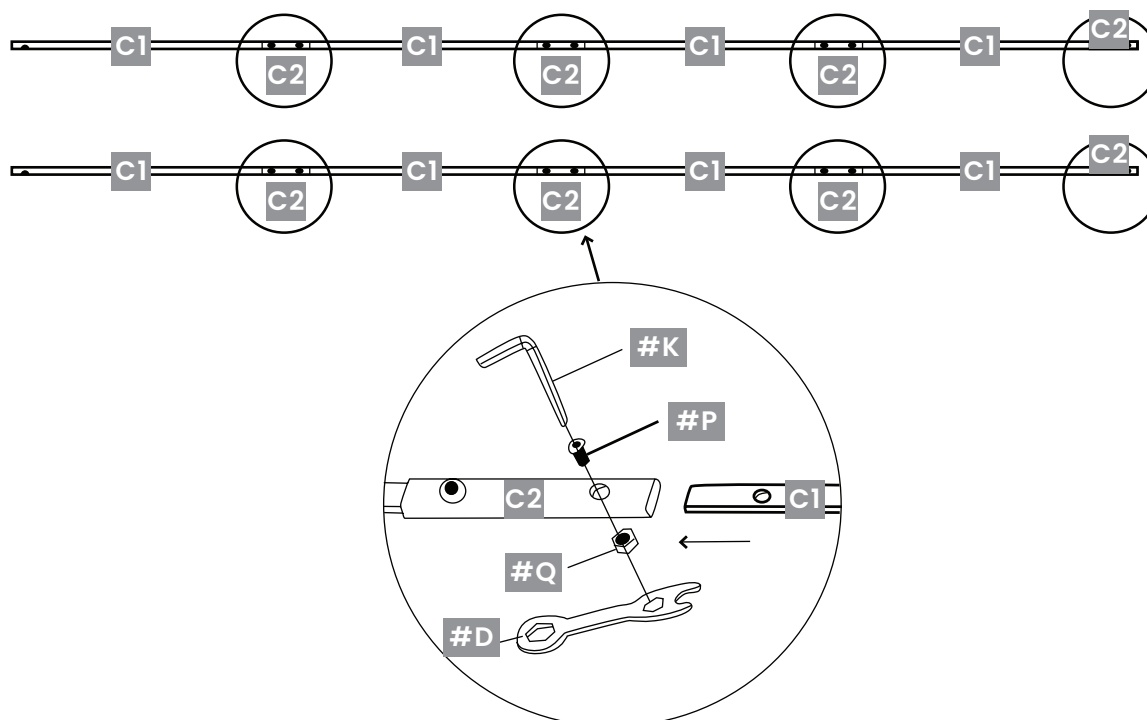

2

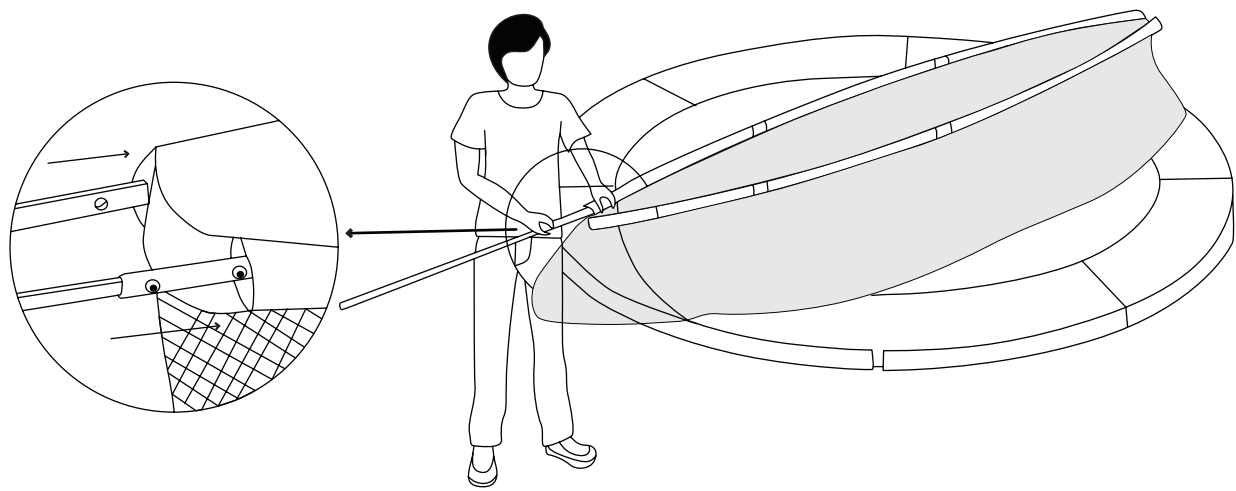

3 WARNING:

Three adults are recommended for this step. Please ensure the assembled Flat Steel frames are held firmly during assembly to avoid them flexing back and causing injury.

With two people firmly holding the ends of the assembled Flat Steel frame, push inward to form a circle. Align the holes and secure the ends with Bolt(# P), Cap Nut(# Q), Allen Wrench(# K) and Wrench(# D) as shown below. This should be done by the third person while the other two people are firmly holding the ends of the tubes in place.

NOTE: Once the enclosure top frame is assembled, make sure the connection points are covered by the enclosure sleeve.

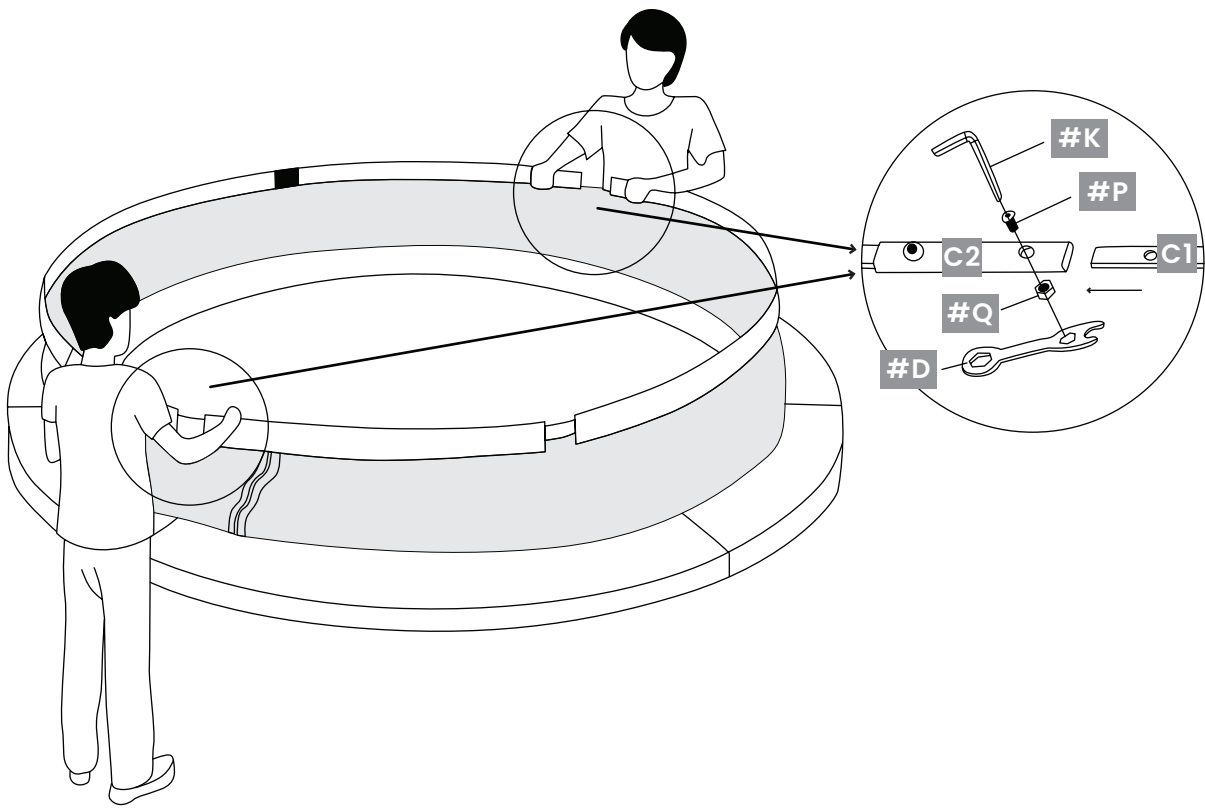

NET ATTACHMENT - 1

STEP 1

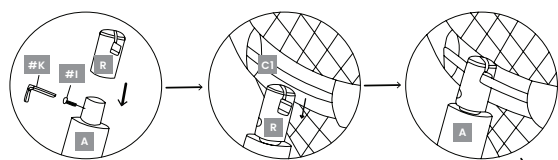

STEP 2

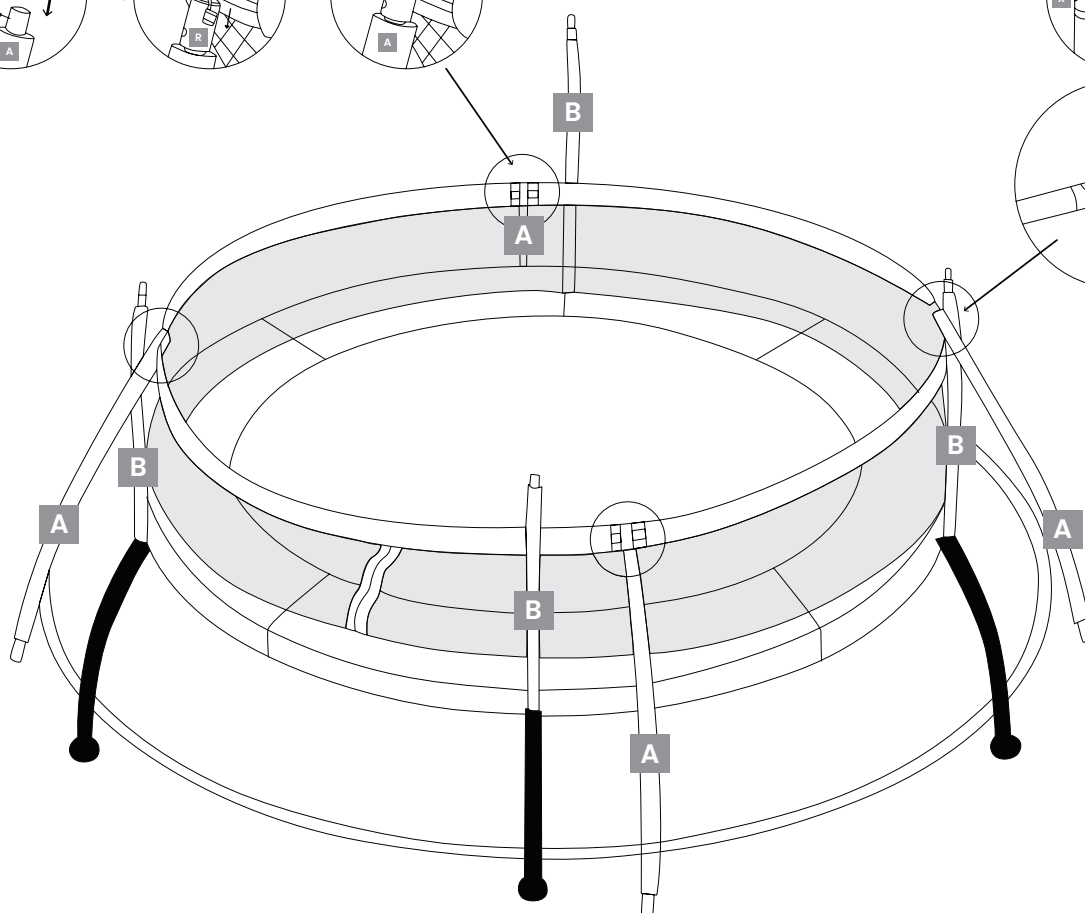
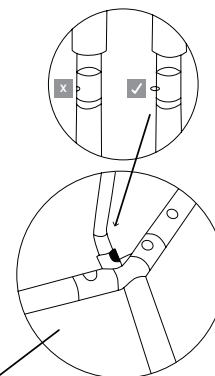

STEP 1

Attach Plastic Cap (# R) to the top of Upper Frame Tube with Foam (#A) Secure with Self-Locking Screw (# I) and tighten using Allen Wrench (# K). Attach the assembled Plastic Cap (# R) to the Flat Steel Bar (# C1) as shown above. Repeat in the same manner for all of the upper frame tubes.

STEP 2

Insert bottom frame tube (B) into Leg bracket, make sure pop-pinned properly. Finally insert the upper frame tubes (A) into swage of bottom frame tubes (B). make sure pop-pinned properly.

NET ATTACHMENT - 2

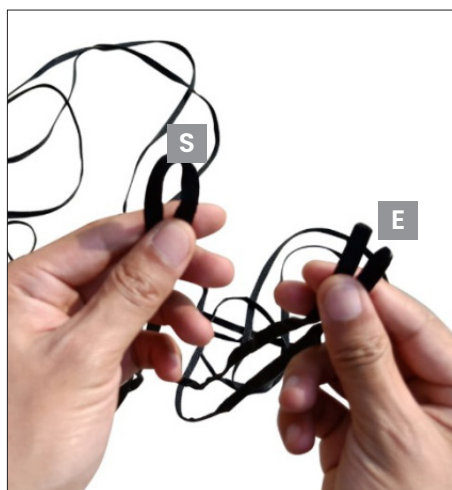
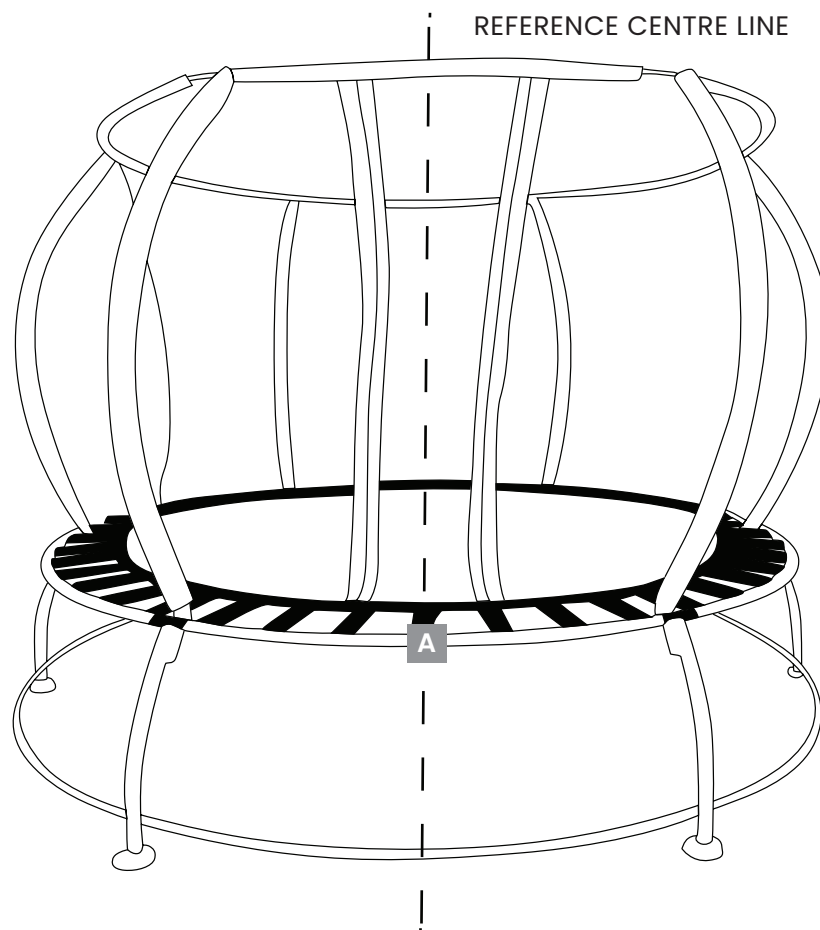

1-1
Fold the rope in half.



1-2
Align the enclosure net against the Centre line to set up the start point "A", then put the "S" end go through the mat D-ring.

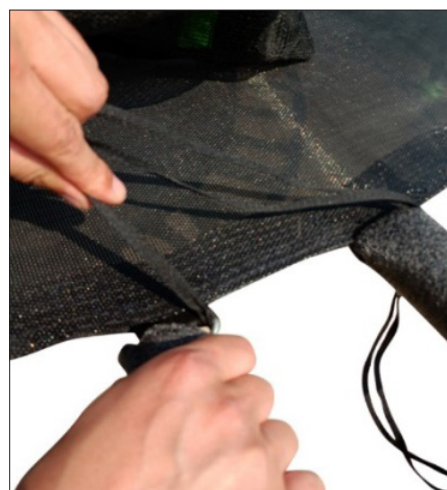

1-3
Put the other end of "E" go through the loop and tight it properly.

NET ATTACHMENT - 3



2-1

Now start the step of threading the rope. We can thread the rope from two directions at the same time. The smart tool is available to easily thread rope, as shown in the figure above.

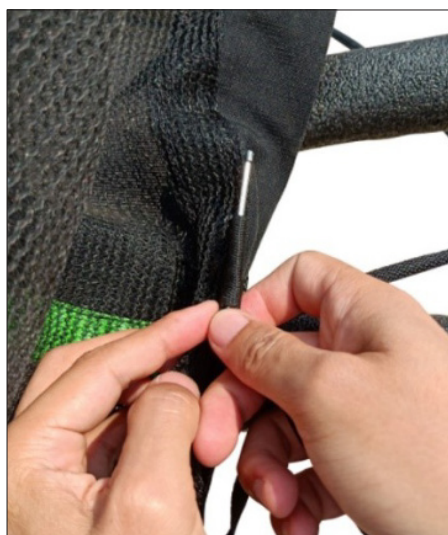

2-2

Thread rope through the loop on net.



2-3

Then thread rope through D-Ring. Repeat step 2-2 & 2-3 until all loops fixed together with D-Rings.

ATTENTION:

Ensure the rope is in the right tension. Ensure no loop missed threading.



3-1

Rope goes through D-Ring twice.

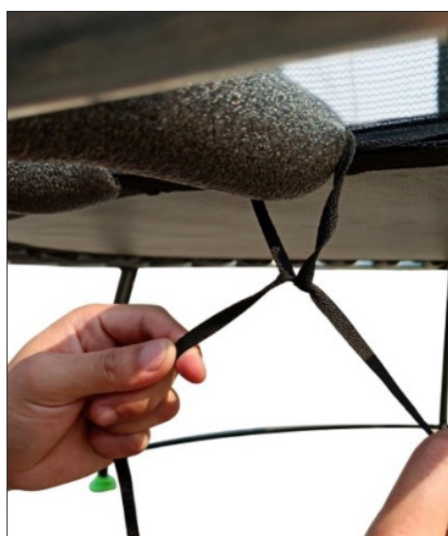

3-2

Tie rope underneath.

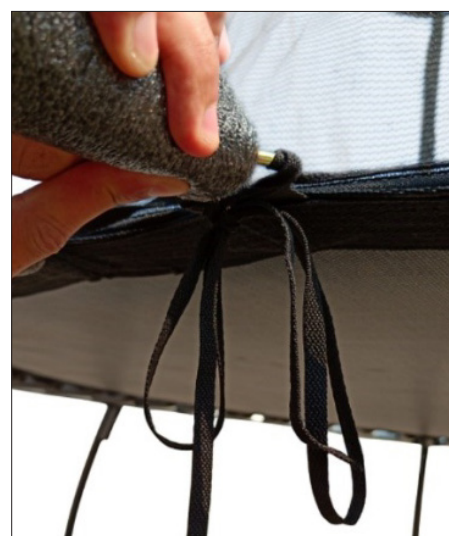

3-3

Tie rope underneath.

ATTENTION:

Daily check the knot, ensure it is in the secure condition.

FRAME PADDING ASSEMBLY

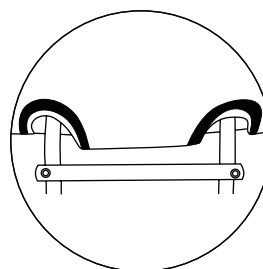
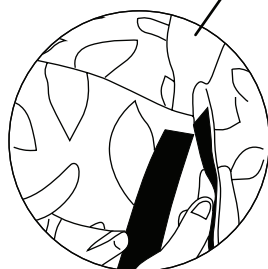
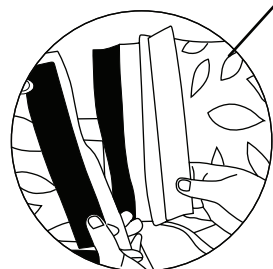
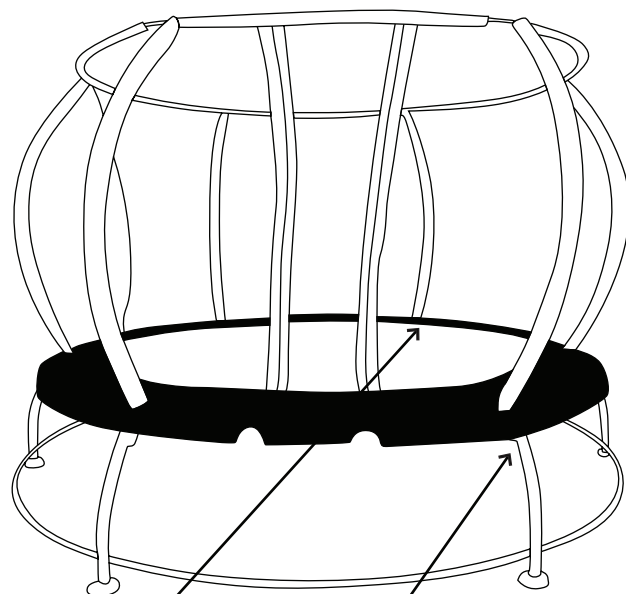

Align pads with
ladder holes

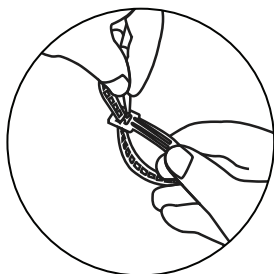
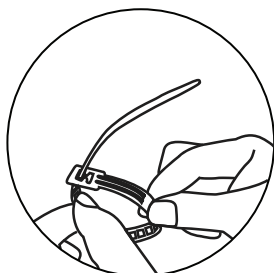

How to thread removable
cable tie.

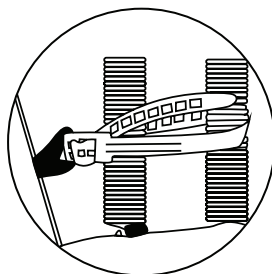
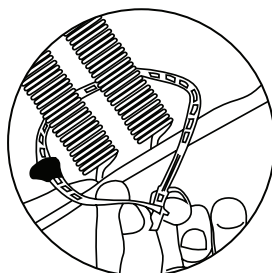

1. Attach pads to springs.

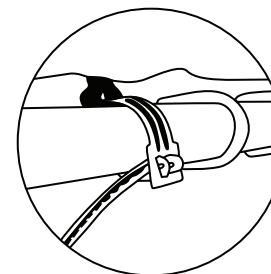
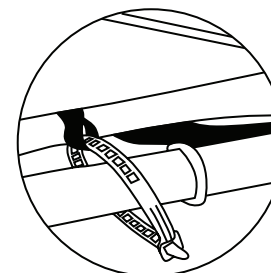

2 Attach pads to frame rail.

LADDER ASSEMBLY

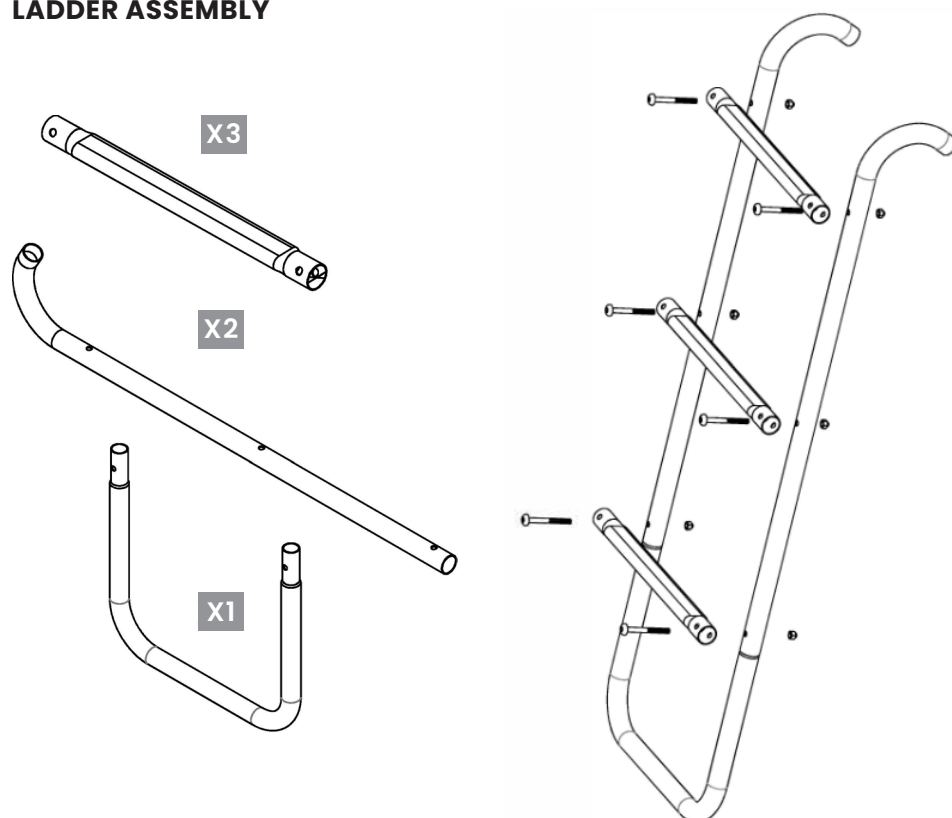

PARTS

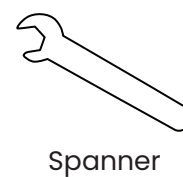
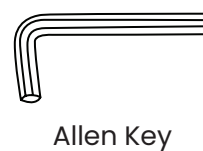
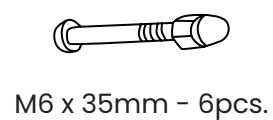

IV. SAFETY NET PRECAUTIONS

In addition to the instructions and precautions provided with your trampoline, the following precautions must be observed while using the Trampoline Safety Enclosure.

- The metal frame of the trampoline enclosure will conduct electricity. Lights, extension cords, and all such electrical equipment must never be allowed to come in contact with the enclosure.
- Inspect the enclosure before each use. Make sure the straps and all parts are correctly and securely positioned and attached. Tighten any loose hardware.
- Replace any worn, defective, or missing parts.
- Wear comfortable clothing free of hooks, snaps, drawstrings for anything which or catch in the safety enclosure mesh. Remove jewellery, necklaces, and earrings.
- Climb on and off the trampoline only through the safety enclosure entrance and securely close entrance when trampoline is in use. Users, especially children, must not attempt to enter or exit between the trampoline frame and the enclosure. Doing this may pose a strangulation risk.
- Do not touch or rebound off the safety enclosure mesh while using the trampoline. Read all instructions and complete all assembly before using the safety enclosure.
- Do not touch or hang off the safety ring (fibre pipe) at the top of the enclosure.
- Use trampoline and trampoline enclosure only with mature, knowledgeable supervision. Adequate overhead clearance is essential. A minimum of 9.5m from ground level is recommended. Provide clearance for wires, tree limbs, and other possible hazards. Lateral clearance is essential. Place the trampoline and trampoline enclosure away from walls, structures, fences, and other play areas. Maintain a clear space on all sides of the trampoline and trampoline enclosure. A minimum of 2 metres from frame edge is recommended.
- The trampoline is heavy and is under heavy tension. Three adults are required to set it up. Use appropriate clothing and shoes. Failure to follow these instructions may lead to injury or damage to the trampoline.
- Place the trampoline and trampoline enclosure on a level surface before use.
- Use the trampoline and trampoline enclosure in a well-lit area. Artificial illumination may be required for indoor or shady areas.
- Secure the trampoline and trampoline enclosure against unauthorized and unsupervised use.
- Remove any obstructions from beneath the trampoline and trampoline enclosure.
- The owner and supervisors of the trampoline and trampoline enclosure are responsible to make all users aware of practices specified in the "Use Instructions".
- The trampoline enclosure is only to be used as an enclosure for a trampoline and the trampoline must be of the appropriate size covered by the specific enclosure.

- Do not allow more than one person on the trampoline or inside the trampoline enclosure. Use by more than one person at the same time can result in serious injuries.
- Use trampoline and trampoline enclosure only with mature, knowledgeable supervision.
- Never set-up the trampoline in heavy rain, wind or storm conditions, especially lightning storms. It is recommended that the trampoline be taken apart and stored in bad weather. When moving the assembled trampoline and trampoline enclosure have at least four people evenly spaced around the frame (NSEW) to lift the trampoline off the ground. Inspect that trampoline and trampoline enclosure before each use. Make sure that frame cover, barrier and, enclosure support padding are correctly and securely positioned.
- Replace any worn, defective, or missing parts.

V. MAINTENANCE

Inspect the trampoline and trampoline enclosure before each use and replace any worn, defective, or missing parts.

The following conditions could represent potential hazards:

1. Missing, improperly positioned, or insecurely attached frame padding, barrier or enclosure support system (frame) padding and pole caps.
2. Punctures, frays, tears, or holes worn in the bed or frame padding, barrier or enclosure support system (frame) padding and pole caps.
3. Deterioration in the stitching or fabric of the bed or frame padding, barrier or enclosure support system (frame) padding and pole caps.
4. Ruptured springs or bands.
5. A bent or broken frame or support system.
6. A sagging barrier or bed.
7. Sharp protrusions on the support (frame) or suspension system.
8. Loosened or missing hardware.

VI. CLEANING

Do not use any abrasive cleansers for the cleaning. Use a soft, damp cloth to eliminate dirt and dust.

VII. EXERCISE DIAGRAMS

FUNDAMENTAL BOUNCES

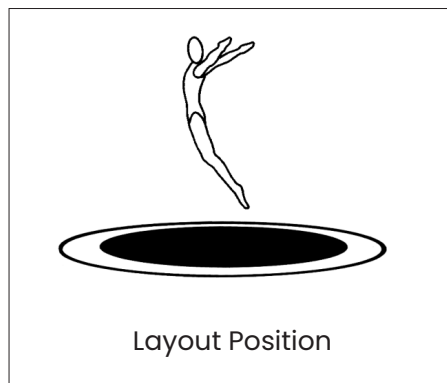
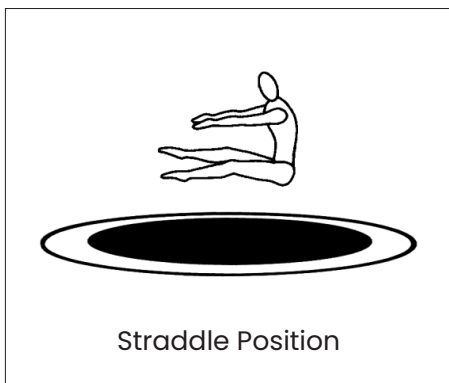
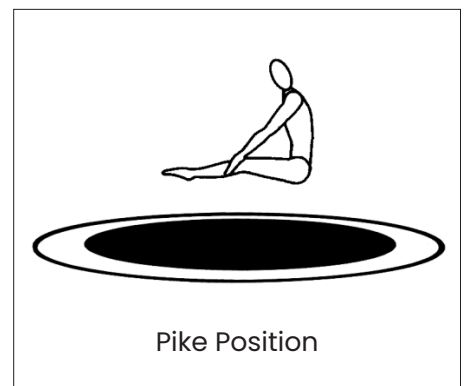
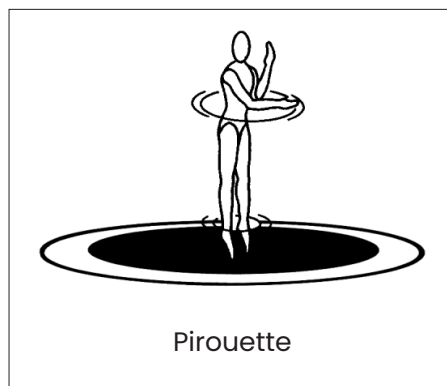
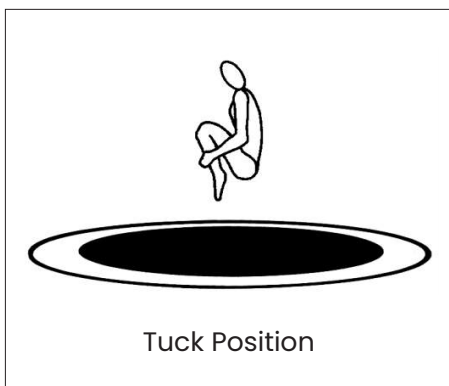
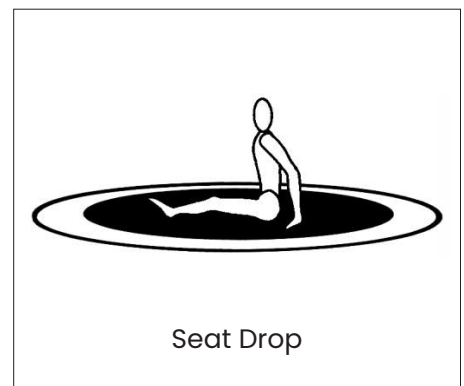
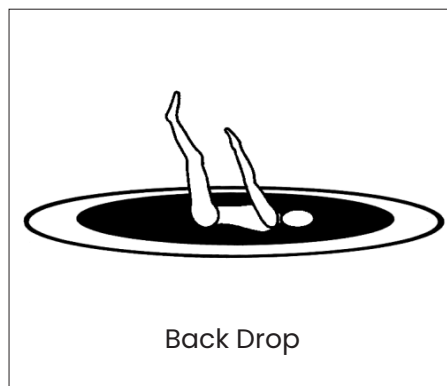
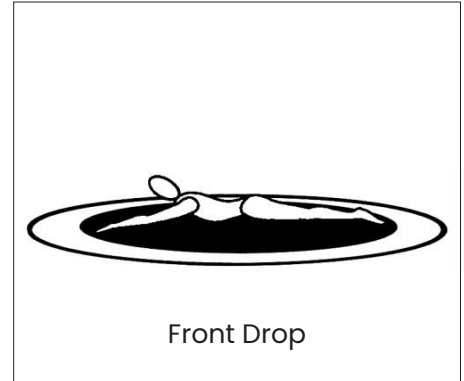
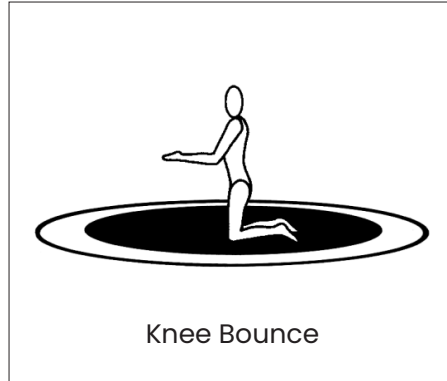
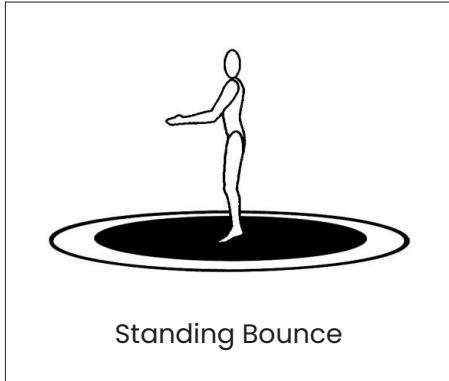

VIII. WARRANTY

AUSTRALIAN CONSUMER LAW

Many of our products come with a guarantee or warranty from the manufacturer. In addition, they come with guarantees that cannot be excluded under the Australian Consumer Law. You are entitled to a replacement or refund for a major failure and compensation for any other reasonably foreseeable loss or damage.

You are entitled to have the goods repaired or replaced if the goods fail to be of acceptable quality and the failure does not amount to a major failure. Full details of your consumer rights may be found at www.consumerlaw.gov.au.

Please visit our website to view our full warranty terms and conditions:
www.lifespankids.com.au/Warranty-Policy-Kids

WARRANTY AND SUPPORT

Any claim against this warranty must be made through your original place of purchase. Proof of purchase is required before a warranty claim may be processed. If you have purchased this product from the Official Lifespan Kids website, please visit www.lifespankids.com.au/warranty-form

For support outside of warranty, if you wish to purchase replacement parts or request a repair or service, please visit www.lifespankids.com.au/warranty-form and fill in our Repair/Service Request Form or Parts Purchase Form.



www.lifespankids.com.au